

RESOLUTION NO. _____

A RESOLUTION OF THE CITY COUNCIL OF THE CITY OF COPPELL, TEXAS IN SUPPORT OF THE DALLAS AREA RAPID TRANSIT RESOLUTION NOS. 210061 AND 210103 RELATED TO THE ADOPTION OF THE SILVER LINE LIGHT RAIL ALIGNMENT; PROVIDING FOR AUTHORIZATION TO EXERCISE EMINENT DOMAIN TO ACQUIRE RIGHT-OF-WAY WITHIN THE CORPORATE LIMITS; PROVIDING FOR A SEVERABILITY CLAUSE; PROVIDING FOR A REPEALING CLAUSE AND PROVIDING WITH AN EFFECTIVE DATE.

WHEREAS, Dallas Area Rapid Transit (DART) was created to provide a regional public transportation system, and the acquisition of real property and the planning, design, engineering, and construction of improvements thereon are functions fundamental to the provision of a public transportation system; and,

WHEREAS, the City of Coppell, in coordination with DART and other stakeholders, identified a mutually advantageous alignment for the Silver Line to include the Cypress Waters station in the City of Dallas; and,

WHEREAS, on August 14, 2018 the City of Coppell City Council approved an Interlocal Agreement with DART; and,

WHEREAS, all property acquisition activities related to the Silver Line are conducted by DART; and

WHEREAS, after careful review of impacted parcels, the DART Board desires to declare the acquisition of parcels a public necessity, to approve the offer of just compensation for these parcels, and to authorize the President/Executive Director or his designee to proceed with the negotiation and purchase of these parcels, and if necessary, the acquisition of these parcels through eminent domain; and

WHEREAS, the property/properties are necessary and proper for construction of the Silver Line Regional Rail Corridor project and for any other use authorized by Chapter 452 of the Texas Transportation Code, and such use is hereby declared to be a public use for a public purpose; and

WHEREAS, on May 25, 2021 and August 10, 2021, the DART Board of Directors approved Resolutions 210061 and 210103 declaring a public necessity, established just compensation, and authorizing the acquisition of property within the City of Coppell for the Silver Line Regional Rail Project through eminent domain proceedings, if necessary; and

WHEREAS, in order for DART to exercise its power of eminent domain, the Coppell City Council must authorize such within the Coppell city limits.

NOW, THEREFORE, BE IT HEREBY RESOLVED BY THE CITY COUNCIL OF THE CITY OF COPPELL THAT:

SECTION 1. The City of Coppell supports DART Board of Directors, Resolution Nos. 210061 and 210103, attached hereto as Exhibit 1, related to the adoption of the Silver Line alignment for light rail service.

SECTION 2. The City of Coppell authorizes DART to exercise eminent domain within the corporate limits of the City of Coppell, Dallas County, Texas for the sole purpose of acquisition of right-of-way for the approved alignment of the Silver Line as set forth in Exhibit 1.

SECTION 3. That any other prior resolution of the City Council in conflict with the provisions contained in this Resolution are hereby repealed and revoked.

SECTION 4. Should any part of this resolution be held to be invalid for any reason, the remainder shall not be affected thereby, and such remaining portions are hereby declared to be severable.

SECTION 5. This resolution shall take effect immediately from and after its passage as provided by law.

DULY PASSED and approved by the City Council of the City of Coppell, Texas, on this the 28th day of September 2021.

APPROVED:

Wes Mays, Mayor

ATTEST:

Ashley Owens, City Secretary

APPROVED AS TO FORM:

Robert E. Hager, City Attorney

RESOLUTION

of the

**DALLAS AREA RAPID TRANSIT BOARD****(Executive Committee)*****RESOLUTION***

Approval to Declare Public Necessity, Establish Just Compensation, and Authorize the Acquisition of Parcels DE1-005 and DE1-006 Located in the City of Coppell, Texas, for the Silver Line Regional Rail Project, and Authorize Eminent Domain Proceedings for These Parcels, if Necessary

WHEREAS, Dallas Area Rapid Transit (DART) was created to provide a regional public transportation system, and the acquisition of real property and the planning, design, engineering, and construction of improvements thereon are functions fundamental to the provision of a public transportation system; and

WHEREAS, the parcels described in Exhibits 1-2 are required for the construction of the Silver Line Regional Rail project; and

WHEREAS, after careful review of these parcels and the recommendation of the Interim President & Chief Executive Officer, the Board desires to declare the acquisition of these parcels a public necessity, to approve the offer of just compensation for these parcels, and to authorize the Interim President & Chief Executive Officer or his designee to proceed with the negotiation and purchase of these parcels, and if necessary, the acquisition of these parcels through eminent domain; and

WHEREAS, funding for these real estate acquisitions is within current Budget and FY 2021 Twenty-Year Financial Plan allocations.

NOW, THEREFORE, BE IT RESOLVED by the Dallas Area Rapid Transit Board of Directors that:

Section 1:

There is a public necessity for the acquisition of Parcel DE1-005 described in Exhibit 1. This property is necessary and proper for construction of the Silver Line Regional Rail Project and for any other use authorized by Chapter 452 of the Texas Transportation Code, and such use is hereby declared to be a public use for a public purpose. The amount to be paid represents just compensation for this parcel required for the Silver Line Regional Rail Project as determined by a Texas State Certified Real Estate Appraiser and reviewed by a Texas State Certified Real Estate Appraiser. In the event the property owner accepts the payment of just compensation, the Interim President & Chief Executive Officer or his designee is hereby authorized to execute all necessary legal instruments and to pay necessary relocation expenses, title policy expenses, closing costs, and other such costs as may be required by law to close the purchase of the property. Should the property owner decline the payment of just compensation, then the Interim President & Chief Executive Officer or his designee is hereby authorized and directed to negotiate the purchase of such parcel in accordance with DART's Real Estate Policy. If the Interim President & Chief Executive Officer or his designee is unable to negotiate the purchase of this parcel for just compensation, the General Counsel is hereby authorized and directed to initiate and prosecute the completion of eminent domain proceedings for the acquisition of this parcel for the Silver Line Regional Rail Project. DART shall not exercise its power of eminent domain for the acquisition of the parcel described in Exhibit 1 without approval of such acquisition by the City Council of the City of Coppell for DE1-005. DART's exercise of the power of eminent domain in acquiring the herein described parcel will not unduly impair the then existing neighborhood character of property surrounding or adjacent to the property to be condemned, nor unduly interfere with interstate commerce, nor authorize DART to run its vehicles on railroad tracks which are used to transport property.

Section 2:

There is a public necessity for the acquisition of Parcel DE1-006 described in Exhibit 2. This property is necessary and proper for construction of the Silver Line Regional Rail Project and for any other use authorized by Chapter 452 of the Texas Transportation Code, and such use is hereby declared to be a public use for a public purpose. The amount to be paid represents just compensation for this parcel required for the Silver Line Regional Rail Project as determined by a Texas State Certified Real Estate Appraiser and reviewed by a Texas State Certified Real Estate Appraiser. In the event the property owner accepts the payment of just compensation, the Interim President & Chief Executive Officer or his designee is hereby authorized to execute all necessary legal instruments and to pay necessary relocation expenses, title policy expenses, closing costs, and other such costs as may be required by law to close the purchase of the property. Should the property owner decline the payment of just compensation, then the Interim President & Chief Executive Officer or his designee is hereby authorized and directed to negotiate the purchase of such parcel in accordance with DART's Real Estate Policy. If the Interim President & Chief Executive Officer or his designee is unable to negotiate the purchase of this parcel for just compensation, the General Counsel is hereby authorized and directed to initiate and prosecute the completion of eminent domain proceedings for the acquisition of this parcel for the Silver Line Regional Rail Project. DART shall not exercise its power of eminent domain for the acquisition of the parcel described in Exhibit 2 without approval of such acquisition by the City Council of the City of Coppel for DE1-006. DART's exercise of the power of eminent domain in acquiring the herein described parcel will not unduly impair the then existing neighborhood character of property surrounding or adjacent to the property to be condemned, nor unduly interfere with interstate commerce, nor authorize DART to run its vehicles on railroad tracks which are used to transport property.

Approval to Declare Public Necessity, Establish Just Compensation, and Authorize the Acquisition of Parcels DE1-005 and DE1-006 Located in the City of Coppell, Texas, for the Silver Line Regional Rail Project, and Authorize Eminent Domain Proceedings for These Parcels, if Necessary

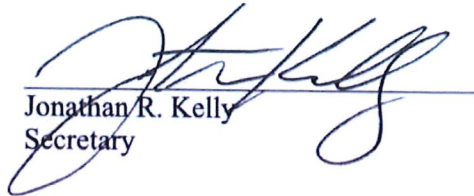
Jonathan R. Kelly
Secretary

Paul N. Wageman
Chair

APPROVED AS TO FORM:

ATTEST

Gene Gamez
General Counsel

David Leininger
Interim President & Chief Executive Officer

May 25, 2021
Date

**Field Notes Describing a 225 Square Foot (0.0052 Acre)
Drainage Easement DE1-005**

Being a 225 Square Foot (0.0052 Acre) tract of land situated in the James A. Simmons Survey, Abstract Number 1296, in the City of Coppell, Dallas County, Texas and being part of Lot 2R-1, Block 2 of the MINOR AMENDING PLAT OF LOT 2R-1 & 2R-2, BLOCK 2, an Addition to the City of Coppell, as recorded in Volume 2000242, Page 1144 of the Deed Records of Dallas County, Texas (D.R.D.C.T.) and being further described as a called 17.278 Acre tract of land conveyed by THE NORTHWESTERN MUTAL LIFE INSUARANCE COMPANY to TEACHERS INSURANCE AND ANNUITY ASSOCIATION OF AMERICA by Special Warranty Deed dated December 19, 2000, as recorded in Volume 2000245, Page 2719, D.R.D.C.T., and being more particularly described by metes and bounds as follows:

BEGINNING at a 5/8 inch iron rod with a yellow plastic cap stamped, "ARS ENGINEERS" set on the north line of said Lot 2R-1, same being the south line of Lot 2, Block 1 of the RE-PLAT OF BLOCK 1 & 2 of the PARK WEST COMMERCE CENTER, an Addition to the City of Coppell, as recorded in Volume 93226, Page 2864, D.R.D.C.T., from which a 1/2 inch yellow capped iron rod stamped, "AH HALFF ASSOC", Controlling Monument (C.M.) found for the southeast corner of Lot 3, Block 1 of said PARK WEST COMMERCE CENTER addition, same being the northeast corner of Lot 2R-2 of said MINOR AMENDING PLAT OF LOT 2R-1 & 2R-2 addition and further being on the existing west Right-Of-Way line of Beltline Road (Variable Width Right-Of-Way) bears: North 88 Degrees 58 Minutes 36 Seconds East, a distance of 784.31 feet.

THENCE departing the common line of said Lot 2R-1, and said Lot 2 and over and across said Lot 2R-1 the following three (3) courses and distances:

1. South 01 degrees 01 minutes 24 seconds East, a distance of 15.00 feet to a "X" cut set for corner;
2. South 88 degrees 58 minutes 36 seconds West, a distance of 15.00 feet to a "X" cut set for corner;
3. North 01 degrees 01 minutes 24 seconds West, a distance of 15.00 feet a 5/8 inch iron rod with a yellow plastic cap stamped, "ARS ENGINEERS" set for corner on the aforementioned common line of Lot 2R-1 and Lot 2;

THENCE North 88 degrees 58 minutes 36 seconds East, along said common line, a distance of 15.00 feet to the **POINT OF BEGINNING** and containing 225 Square Feet or 0.0052 Acres of land.

DETAIL - N.T.S.

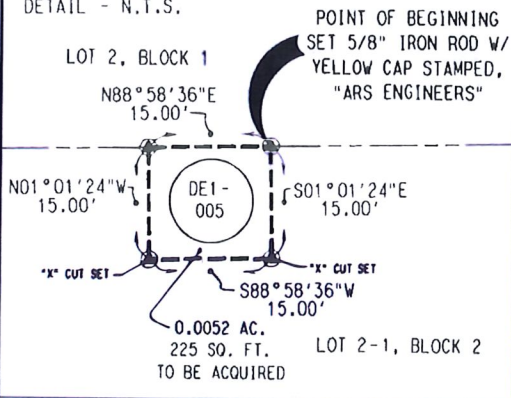

Enclosure 1
NOTES:

- All bearings and coordinates are based on the Texas State Plane Coordinate System NAD 83 (2011) North Central Zone (4202). Ref Stations: ZFW1 and TXCO
- All distances shown are surface values and may be converted to grid by dividing by the conversion factor for Dallas County of 1.000158506

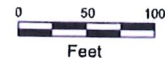

MLRP PARK WEST LAND LLC
SPECIAL WARRANTY DEED
TRACT 1
INST. No. 201400043575
O.P.R.D.C.C.T.

LOT 2, BLOCK 1
RE-PLAT OF BLOCK 1 AND 2
PARK WEST COMMERCE CENTER
VOL. 93226, PG. 2864
D.R.D.C.C.T.

POINT OF BEGINNING
SET 5/8" IRON ROD W/
YELLOW CAP STAMPED,
"ARS ENGINEERS"

N88°58'36"E - 784.31'

1/2" YELLOW C.I.R.F.
STAMPED, "AH HALFF
ASSOC., C.M."

BELTLINE ROAD (VARIABLE WIDTH R.O.W.)
EXISTING RIGHT-OF-WAY

20' UTILITY ESMNT., VOL. 93226, PG. 2864, D.R.D.C.C.T.

TXU ELECTRIC ESMNT.
VOL. 2000242, PG. 1144
D.R.D.C.C.T.

MINOR AMENDING PLAT
LOT 2R-1 & 2R-2, BLOCK 2
PARK WEST COMMERCE CENTER
VOL. 2000242, PG. 1144
D.R.D.C.C.T.

TRACT 2 - CALLED 17.278 ACRES
THE NORTHWESTERN MUTUAL
LIFE INSURANCE COMPANY
CONVEYS TO TEACHERS INSURANCE AND
ANNUITY ASSOCIATION OF AMERICA
FILED DECEMBER 19, 2000
SPECIAL WARRANTY DEED
VOL. 2000245, PG. 2719
D.R.D.C.C.T.

MINOR AMENDING PLAT
LOT 2R-1 & 2R-2, BLOCK 2
PARK WEST COMMERCE CENTER
VOL. 2000242, PG. 1144
D.R.D.C.C.T.

MH MAJESTIC HOLDINGS, LLC
GENERAL WARRANTY DEED
TRACT 1
INST. No. 20050363878
O.P.R.D.C.C.T.

LOT 2R-2, BLOCK 2

LEGEND

- SIGN
 - UTILITY POLE
 - LIGHT POLE
 - EXISTING RIGHT-OF-WAY
 - PROPERTY LINE
 - PROPOSED DRAINAGE EASEMENT LINE
- D.P.R.D.C.C.T. OFFICIAL PUBLIC RECORDS, DALLAS COUNTY, TEXAS
- D.R.D.C.C.T. DEED RECORDS, DALLAS COUNTY, TEXAS
- (CM) CONTROLLING MONUMENT
- 5/8 INCH DIAMETER IRON ROD WITH YELLOW PLASTIC CAP
 - STAMPED "ARS ENGINEERS" SET, UNLESS OTHERWISE NOTED
 - FOUND IRON ROD OR MONUMENT AS NOTED

I HEREBY CERTIFY THAT THIS PLAT IS BASED ON AN ON THE GROUND SURVEY MADE UNDER MY SUPERVISION AND, TO THE BEST OF MY KNOWLEDGE, IS TRUE AND CORRECT.

Dustin D. Davison 3-18-2021
DUSTIN D. DAVISON, R.P.L.S. TEXAS No. 6451



Sheet 3 of 3

Exhibit 1

COTTON BELT REGIONAL RAIL SYSTEM
A 225 SQUARE FOOT (0.0052 ACRES)
DRAINAGE EASEMENT DE1-005
TO BE ACQUIRED FROM
TEACHERS INSURANCE AND ANNUITY
ASSOCIATION OF AMERICA

DATE	11-30-00
DRAWN	C WALLWORK
DESIGNED	DDAVISON
CHECKED	TSANTOS
IN CHARGE	DDAVISON
DATE	2/19/2021

CONTRACT 14806367
ENC. NO. RP3-2000

DART PROJECT

DART

©DART, all rights reserved. 1981-2019

ARS Engineers, Inc.
12027 N. Central Expressway, Suite 1200
(214) 752-2122 Fax (214) 752-3168
Engineering Firm #4475 Surveying Firm #10329-00

210061

Field Notes Describing a 450 Square Foot (0.0103 Acres)
Parcel DE1-006

BEING a 450 square feet or 0.0103 acre tract of land situated in the James A. Simmons Survey, Abstract No. 1296, City of Coppell, Dallas County, Texas, said 450 square feet of land being a portion of **LOT 2R-3, BLOCK 2, PARK WEST COMMERCE CENTER**, being an Addition to the said City and State, according to the plat thereof recorded in Instrument Number 200503563883, Official Public Records, Dallas County, Texas (O.P.R.D.C.T.), said 450 square feet of land being a portion of that certain tract of land that The Northwestern Mutual Life Insurance Company conveyed to **NM MAJESTIC HOLDINGS, LLC**, by special warranty deed, as recorded in Dallas County Clerk's Instrument Number 200503634878, O.P.R.D.C.T., said 450 square feet of land being more particularly described by metes and bounds as follows:

BEGINNING at a 5/8 inch iron rod with a cap stamped "SPOONER 5922" set on the north lot line of said Lot 2R-3, same being the south lot line of Lot 3, Block 1, Park West Commerce Center, being an Addition to the said City and State, according to the plat thereof filed for record in Volume 93226, Page 2864, Deed Records, Dallas County, Texas, said beginning point being South 88°58'36" West, 394.25 feet from a 1/2 inch iron rod with a cap stamped "A.H. HALFF" found (controlling monument) at the northeast lot corner of said Lot 2R-3, same being the southeast lot corner of said Lot 3, said iron rod found also being on the west right-of-way line of S. Belt Line Road (being a variable width public right-of-way);

THENCE South 01°01'24" East, departing the said lot lines and over and across said Lot 2R-3, 30.00 feet to an X-cut set on the north line of an existing 24 feet wide Fire Lane and Access Easement, being shown on and dedicated by deed thereof filed for record in Volume 2005149, Page 191, O.P.R.D.C.T.;

THENCE South 88°58'36" West, along the said easement line, 15.00 feet to an X-cut set;

THENCE North 01°01'24" West, departing the said easement line and continuing over and across said Lot 2R-3, 30.00 feet to a 5/8 inch iron rod with a cap stamped "SPOONER 5922" set on the said lot lines, from said iron rod set, a 5/8 inch iron rod with a cap stamped "SPOONER 5922" found (controlling monument) at the southwest lot corner of said Lot 3, same being the southeast lot corner of Lot 2 of said Block 1 bears South 88°58'36" West, 153.29 feet;

THENCE North 88°58'36" East, along the said north lot line and along the said south lot line, 15.00 feet to the **POINT OF BEGINNING**, containing 450 square feet or 0.0103 acres of land.

NOTE: All bearings and coordinates as based on the Texas State Plane Coordinate System, NAD-83 (2011), North Central Zone (4202). The horizontal datum derived from the 2019 NAD-83 Published (CORS) Stations ZFW1 and TXCO. All distances shown are surface values and may be converted to grid by dividing by the conversion factor for Dallas County of 1.000136506.



1/13/21

Surveyors Name: Eric S. Spooner
Registered Professional Land Surveyor, Texas No. 5922
Spooners and Associates, Inc.
Texas Board of Professional Land Surveying No. 10054900



Enclosure 1

Exhibit 2

Sheet 2 of 2



- LEGEND**
- EASEMENT TO BE ACQUIRED
 - O.P.R.D.C.T.** OFFICIAL PUBLIC RECORDS, DALLAS COUNTY, TEXAS
 - D.R.D.C.T.** DEED RECORDS, DALLAS COUNTY, TEXAS
 - (CM)** CONTROLLING MONUMENT
 - 5/8 INCH IRON WITH CAP STAMPED "SPOONER 5922" SET
 - FOUND IRON ROD
 - X-CUT SET

*JAMES A. SIMMONS
SURVEY
ABS. NO. 1296*

LINE TABLE		
LINE #	BEARING	LENGTH
L1	S01°01'24"E	30.00'
L2	S88°58'36"W	15.00'
L3	N01°01'24"W	30.00'
L4	N88°58'36"E	15.00'

LOT 2, BLOCK 1,
PARK WEST COMMERCE CENTER
VOLUME 93226, PAGE 2864,
D.R.D.C.T.
MLRP PARK WEST LAND, LLC
D.C.C.I. NO. 201400045575,
O.P.R.D.C.T.

LOT 3, BLOCK 1,
PARK WEST COMMERCE CENTER
VOLUME 93226, PAGE 2864,
D.R.D.C.T.
MLRP PARK WEST LAND LLC
D.C.C.I. NO. 201400045575,
FILED FEBRUARY 25, 2014
O.P.R.D.C.T.

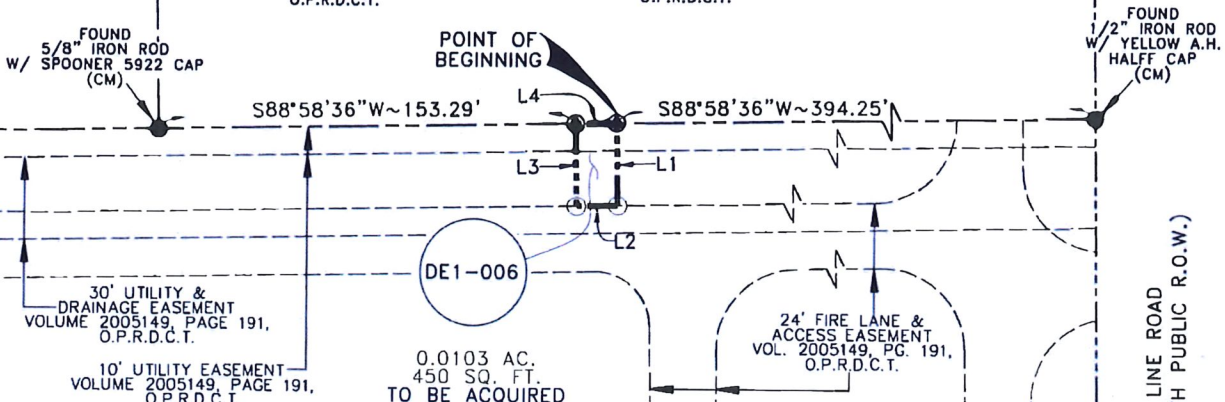

COTTON BELT REGIONAL RAIL SYSTEM
PARCEL DE1-006
A 450 SQ. FOOT (0.0103 ACRES)
PARCEL TO BE ACQUIRED FROM
NM MAJESTIC HOLDINGS, LLC

SCALE 1"=50'
DRAWN ROSMONT
CHECKED JACOBS
IN CHARGE JACOBS
DATE 01-07-2021
CAES

DART PROJECT
DART
©DART. All rights reserved. 1987-2019

SPOONER & ASSOCIATES
OVER 35 YEARS OF SERVICE
300 WILSON STREET, SUITE 100, ELLENSBURG, TEXAS 76038
(817) 656-4444
TIPSA@SPOONERASSOCIATES.COM

- NOTES:**
- All bearing and coordinates as based on the Texas State Plane Coordinate System NAD 83 (2011) North Central Zone (4202). The horizontal datum derived from the 2019 NAD 83 Published (CORS) Stations ZFW1 and TXCO.
 - All distances shown are surface values and may be converted to grid by dividing by the conversion factor for Dallas County of 1.000136506
 - This survey was performed without the benefit of a title commitment.
 - Easements were not researched by the surveyor.

0.0103 AC.
450 SQ. FT.
TO BE ACQUIRED



LOT 2R-3, BLOCK 2,
PARK WEST COMMERCE CENTER
INST.NO. 200503563883,
O.P.R.D.C.T.
THE NORTHWESTERN MUTUAL
LIFE INSURANCE COMPANY TO
NM MAJESTIC HOLDINGS, LLC
INST. NO. 200503634878,
O.D.R.D.C.T.

S. BELT LINE ROAD
(VARIABLE WIDTH PUBLIC R.O.W.)

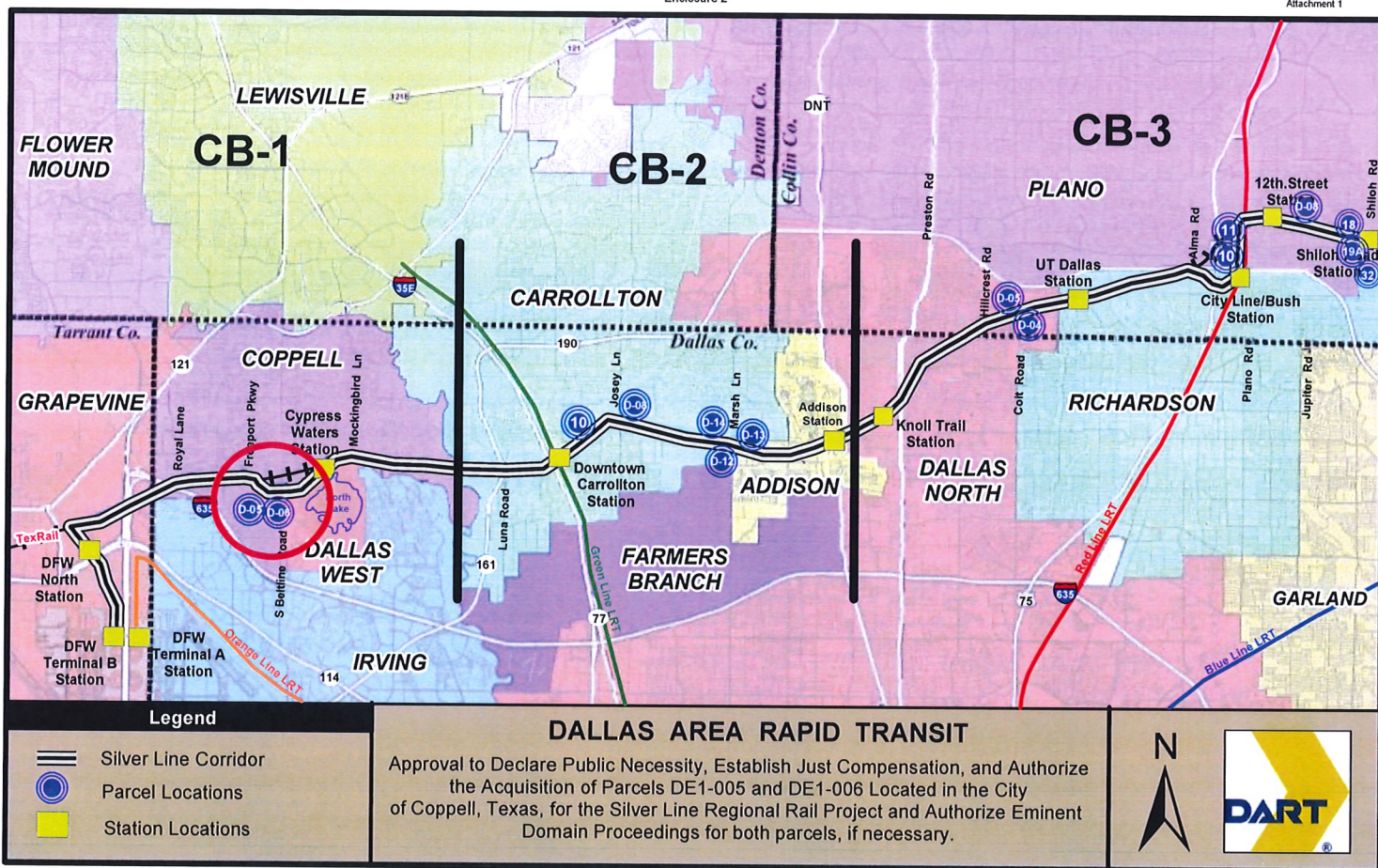
210061



Legend

-  Silver Line Corridor
-  Parcel Locations
-  Station Locations



DALLAS AREA RAPID TRANSIT

Approval to Declare Public Necessity, Establish Just Compensation, and Authorize the Acquisition of Parcels DE1-005 and DE1-006 Located in the City of Coppell, Texas, for the Silver Line Regional Rail Project and Authorize Eminent Domain Proceedings for both parcels, if necessary.





Legend

-  Silver Line Corridor
-  Property Boundaries
-  Area To Be Acquired

DALLAS AREA RAPID TRANSIT

Approval to Declare Public Necessity, Establish Just Compensation, and Authorize the Acquisition of Parcels DE1-005 and DE1-006 Located in the City of Coppell, Texas, for the Silver Line Regional Rail Project and Authorize Eminent Domain Proceedings for both parcels, if necessary.

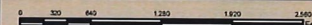

RESOLUTION

of the



DALLAS AREA RAPID TRANSIT BOARD

(Executive Committee)

RESOLUTION

Approval to Declare Public Necessity, Establish Just Compensation, and Authorize the Acquisition of Parcel CB1-014B Located in the City of Coppell, Texas, for the Silver Line Regional Rail Project, and Authorize Eminent Domain Proceedings, if Necessary

WHEREAS, Dallas Area Rapid Transit (DART) was created to provide a regional public transportation system, and the acquisition of real property and the planning, design, engineering, and construction of improvements thereon are functions fundamental to the provision of a public transportation system; and

WHEREAS, the parcel described in Exhibit 1 is required for the construction of the Silver Line Regional Rail project; and

WHEREAS, after careful review of this parcel and the recommendation of the President & Chief Executive Officer, the Board desires to declare the acquisition of this parcel a public necessity, to approve the offer of just compensation for this parcel, and to authorize the President & Chief Executive Officer or her designee to proceed with the negotiation and purchase of this parcel, and if necessary, the acquisition of this parcel through eminent domain; and

WHEREAS, funding for this real estate acquisition is within current Budget and FY 2021 Twenty-Year Financial Plan allocations.

NOW, THEREFORE, BE IT RESOLVED by the Dallas Area Rapid Transit Board of Directors that there is a public necessity for the acquisition of Parcel CB1-014 described in Exhibit 1. This property is necessary and proper for construction of the Silver Line Regional Rail Project and for any other use authorized by Chapter 452 of the Texas Transportation Code, and such use is hereby declared to be a public use for a public purpose. The amount to be paid represents just compensation for this parcel required for the Silver Line Regional Rail Project as determined by a Texas State Certified Real Estate Appraiser and reviewed by Texas State Certified Real Estate Appraiser. In the event the property owner accepts the payment of just compensation, the President & Chief Executive Officer or her designee is hereby authorized to execute all necessary legal instruments and to pay necessary relocation expenses, title policy expenses, closing costs, and other such costs as may be required by law to close the purchase of the property. Should the property owner decline the payment of just compensation, then the President & Chief Executive Officer or her designee is hereby authorized and directed to negotiate the purchase of such parcel in accordance with DART's Real Estate Policy. If the President & Chief Executive Officer or her designee is unable to negotiate the purchase of this parcel for just compensation, the General Counsel is hereby authorized and directed to initiate and prosecute the completion of eminent domain proceedings for the acquisition of this parcel for the Silver Line Regional Rail Project. DART shall not exercise its power of eminent domain for the acquisition of the parcel described in Exhibit 1 without approval of such acquisition by the City Council of the City of Coppell for CB1-014B. DART's exercise of the power of eminent domain in acquiring the herein described parcel will not unduly impair the then existing neighborhood character of property surrounding or adjacent to the property to be condemned, nor unduly interfere with interstate commerce, nor authorize DART to run its vehicles on railroad tracks which are used to transport property.

Approval to Declare Public Necessity, Establish Just Compensation, and Authorize the Acquisition of Parcel CB1-014B Located in the City of Coppell, Texas, for the Silver Line Regional Rail Project, and Authorize Eminent Domain Proceedings, if Necessary



Jonathan R. Kelly
Secretary

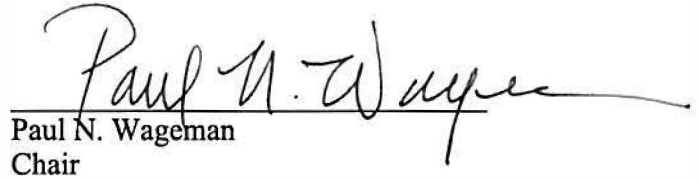

Paul N. Wageman
Chair

APPROVED AS TO FORM:



Gene Gamez
General Counsel

ATTEST



Nadine S. Lee
President & Chief Executive Officer

August 10, 2021
Date

**Field Notes Describing a 11,053 Square Foot (0.2537 Acres)
Parcel CB1-014B**

Exhibit 1

BEING a 11,053 square feet or 0.2537 acre tract of land situated in the James A. Simmons Survey Abstract No. 1296, City of Coppell, Dallas County, Texas, said 11,053 square feet of land being a portion of the apparent abandoned right-of-way of Old Coppell Road, being a public right-of-way of unknown width as shown on Dallas County Plat Books, Abstract No. 1296, Sheet 1. Said right-of-way is no longer in public use and record of official abandonment not found, said 11,053 square feet of land being more particularly described by metes and bounds as follows;

COMMENCING at a 5/8 inch iron rod with a cap stamped "JDJR 4184" found (controlling monument) at the most westerly southwest property corner of a called 3.729 acre tract conveyed to Amado Soto and Flora Soto, by deed thereof filed for record Volume 81147, Page 2027, D.R.D.C.T., same being the southeast property corner of a called 1.298 acre tract conveyed to Hummingbird Flight, LLC, by deed thereof filed for record in Instrument Number 201600007206, Official Public Records, Dallas County, Texas (O.P.R.D.C.T.), said commencing point being on the north right-of-way line of Southwestern Boulevard (being a variable width public right-of-way) from which a 3/8 inch iron rod in concrete found (controlling monument) at the most westerly northwest property corner of the said 3.729 acre tract, same being the northeast property corner of the said 1.298 acre tract, and further being on the southerly right-of-way line of a tract of land conveyed to Dallas Area Rapid Transit, by deed thereof filed for record in Volume 91008, Page 1341, D.R.D.C.T., bears North 00°41'45" West, 232.94 feet, said commencing point also being at the beginning of a non-tangent curve to the right having a radius of 488.40 feet;

THENCE along the southwest property line of the said 3.729 acre tract, along the said north right-of-way line, with said curve to the right, through a central angle of 2°05'03", an arc length of 17.77 feet, and across a chord which bears South 73°16'25" East, a chord length of 17.77 feet to a 5/8 inch iron rod with a cap stamped "SPOONER 5922" set at the **POINT OF BEGINNING** of the herein described tract of land, said beginning point being at the most southerly southwest property corner of the said 3.729 acre tract;

THENCE North 87°21'24" East, departing the said north right-of-way line and along the south property line of the said 3.729 acre tract, 530.82 feet to a 1 inch iron pipe in concrete found at the southeast property corner of the said 3.729 acre tract, said iron pipe found also being on the west property line of a called 1.321 acre tract conveyed to Daniel C. Soto, by deed thereof filed for record in Volume 200043, Page 7002, O.P.R.T.C.T.;

THENCE South 00°36'54" East, along the said west property line of the 1.321 acre tract, 32.50 feet to a 5/8 inch iron rod with a cap stamped "SPOONER 5922" set at the most northerly northeast property corner of a 0.954 acre tract of land that Amado Soto conveyed to the Amado Soto's Enterprises, Inc., by Warranty Deed, as recorded in Volume 94221, Page 2030, filed November 15, 1994, Deed Records, Dallas County, Texas (D.R.D.C.T.);

THENCE North 89°50'54" West, departing the said west property line and along the north property line of the said 0.954 acre tract, 416.27 feet to a 5/8 inch iron rod with a cap stamped "SPOONER 5922" set at the northwest property corner of the said 0.954 acre tract;

THENCE South 01°23'50" West, along the west property line of the said 0.954 acre tract, 18.44 feet to a 5/8 inch iron rod with a cap stamped "SPOONER 5922" set at the southwest property corner of the said 0.954 acre tract, said capped iron rod set also being on the said north right-of-way line of Southwestern Boulevard;

THENCE North 77°27'05" West, along the said right-of-way line, 116.67 feet to the **POINT OF BEGINNING**, containing 11,053 square feet or 0.2537 acres of land.

Field Notes Describing a 11,053 Square Foot (0.2537 Acres)
Parcel CBI-014B

NOTE: All bearings and coordinates are based on the Texas State Plane Coordinate System, NAD-83 (2011), North Central Zone (4202). The horizontal datum derived from the 2019 NAD-83 Published (CORS) Stations ZFW1 and TXCO. All distances shown are surface values and may be converted to grid by dividing by the conversion factor for Dallas County of 1.000136506.



6/7/21

Surveyor's Name: Eric S. Spooner
Registered Professional Land Surveyor, Texas No. 5922
Spooners and Associates, Inc.
Texas Board of Professional Land Surveying No. 10054900



CURVE TABLE					
CURVE #	RADIUS	DELTA	ARC LENGTH	CHORD BEARING	CHORD LENGTH
C1	488.40'	2°05'03"	17.77'	S73°16'25"E	17.77'

LINE TABLE		
LINE #	BEARING	LENGTH
L1	N87°21'24"E	530.82'
L2	S00°36'54"E	32.50'
L3	N89°50'54"W	416.27'
L4	S01°23'50"W	18.44'
L5	N77°27'05"W	116.67'

Exhibit 1

*JAMES A. SIMMONS
SURVEY
ABS. NO. 1296*

Sheet 3 of 3

Enclosure 1
COTTON BELT REGIONAL RAIL SYSTEM
PARCEL CB1-014B
A 11,053 SQUARE FOOT (0.2537 ACRE) PARCEL TO BE ACQUIRED
OLD COPPELL ROAD

CONTRACT C-2033270-01
DWG No. 19054-CB1-014B.dgn

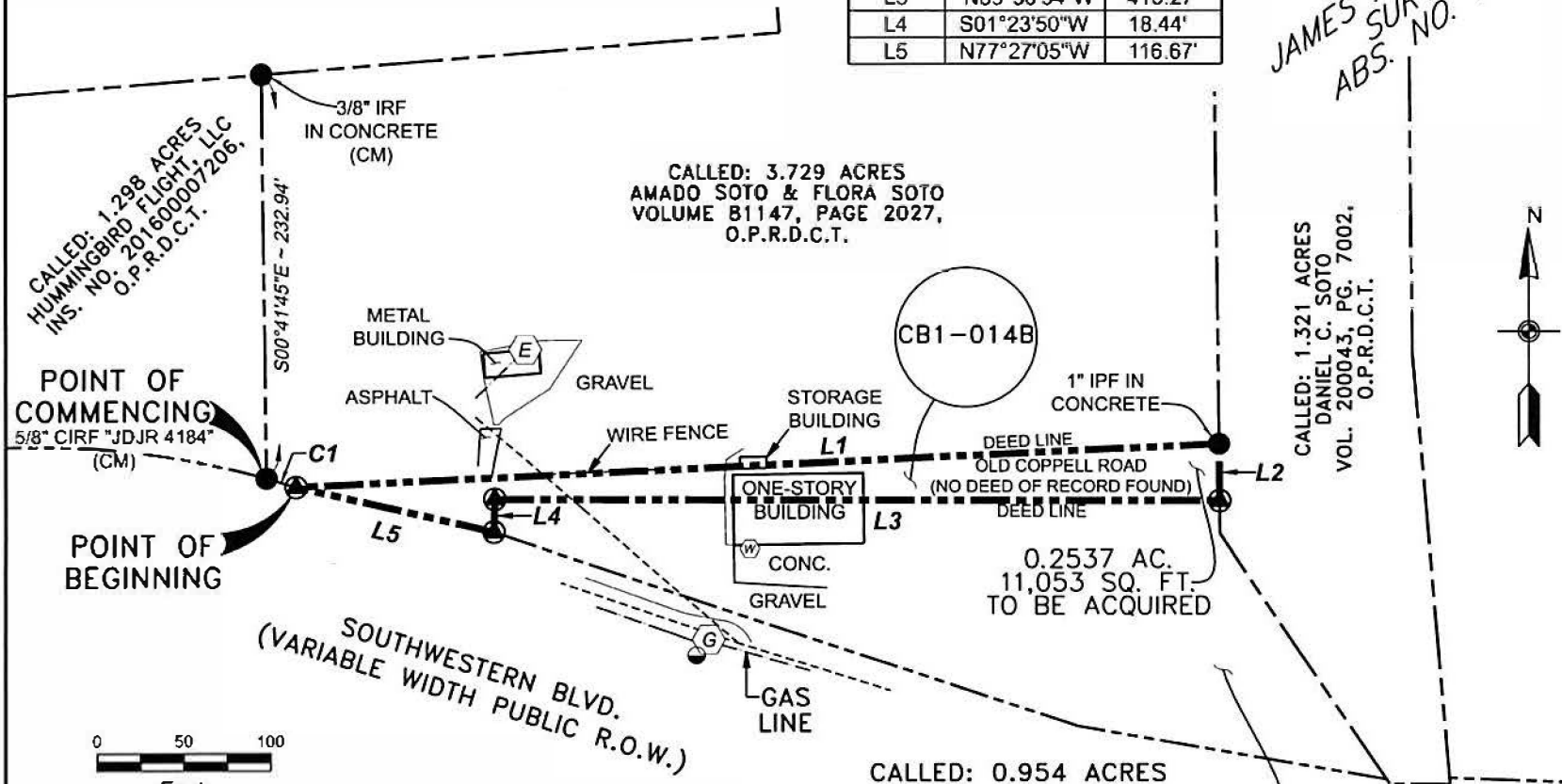

CALLLED: 1.298 ACRES
HUMMINGBIRD FLIGHT, LLC
INS. NO: 201600007206,
O.P.R.D.C.T.

CALLLED: 3.729 ACRES
AMADO SOTO & FLORA SOTO
VOLUME 81147, PAGE 2027,
O.P.R.D.C.T.

CALLLED: 1.321 ACRES
DANIEL C. SOTO
VOL. 200043, PG. 7002,
O.P.R.D.C.T.

CALLLED: 0.954 ACRES
AMADO SOTO TO
AMADO SOTO'S ENTERPRISES, INC.
VOLUME 94221, PAGE 2030,
FILED NOVEMBER 15, 1994
O.P.R.D.C.T.

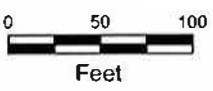

LEGEND

- RIGHT OF WAY TO BE ACQUIRED
- O.P.R.D.C.T. OFFICIAL PUBLIC RECORDS, DALLAS COUNTY, TEXAS
- D.R.D.C.T. DEED RECORDS, DALLAS COUNTY, TEXAS
- (CM) CONTROLLING MONUMENT
- 5/8 INCH IRON ROD WITH A CAP
- STAMPED "SPOONER 5922" SET
- FOUND IRON ROD
- ELECTRIC METER
- WATER METER
- GAS METER
- OVERHEAD UTILITY
- CLEAN OUT

NOTES:

1. All bearing and coordinates as based on the Texas State Plane Coordinate System, NAD 83 (2011) North Central Zone (4202). The horizontal datum derived from the 2019 NAD 83 Published (CORS) Stations ZFW1 and TXCO.
2. All distances shown are surface values and may be converted to grid by dividing by the conversion factor for Dallas County of 1.000136506
3. This survey was performed without the benefit of a title commitment.
4. Easements were not researched by the surveyor.

SCALE	1" = 100'
DRAWN	R OSment
DESIGNED	Jacobs
CHECKED	E Spooner
IN CHARGE	Jacobs
DATE	05-26-2021

DART PROJECT

©DART, all rights reserved, 1987-2019

SPOONER & ASSOCIATES
SURVEYING & ENGINEERING
OVER 25 YEARS OF SERVICE
300 BYERS STREET, SUITE 100 EL PASO, TEXAS 79901
(917) 663-6448 WWW.SPOONERASSOCIATES.COM
TIPALS PERM NO. 10064900

210103

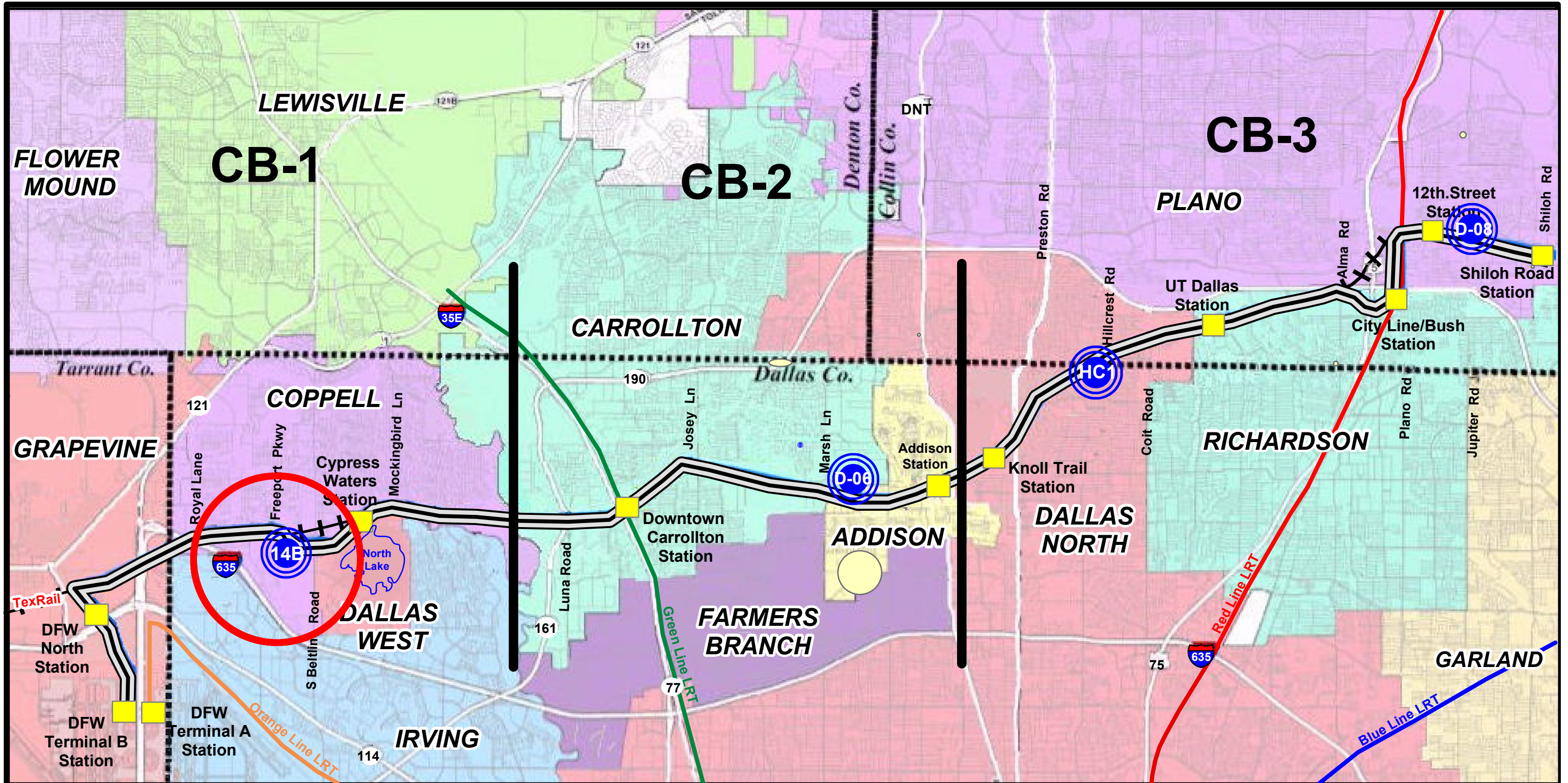

Legend

-  Silver Line Corridor
-  Parcel Locations
-  Station Locations



DALLAS AREA RAPID TRANSIT
SILVER LINE REGIONAL RAIL CORRIDOR

N

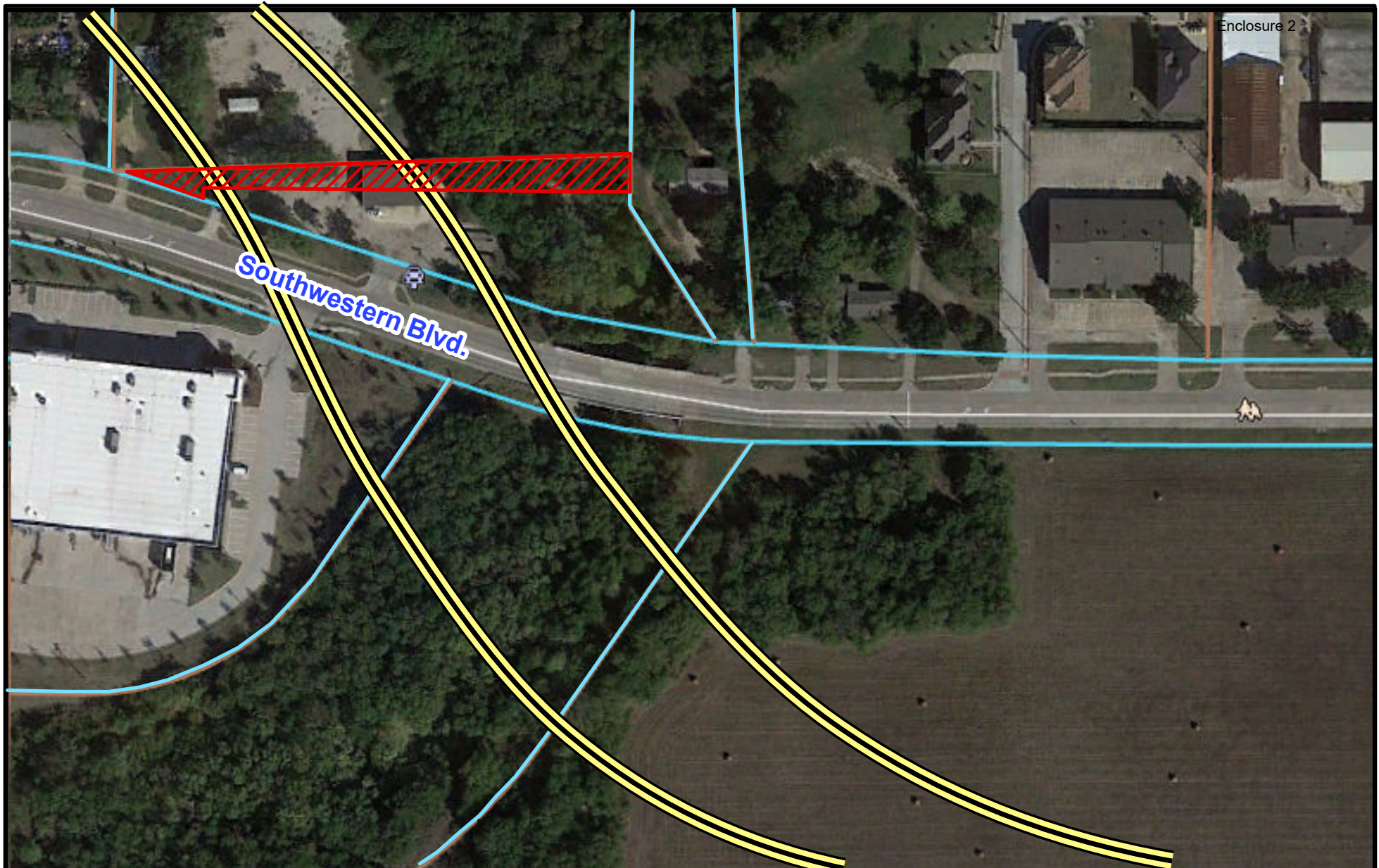

Legend

-  Silver Line Corridor
-  Area To Be Acquired - CB1-14B
-  Property Boundaries

DALLAS AREA RAPID TRANSIT

Declare Public Necessity, Establish Just Compensation, and Authorize the Acquisition of Parcels CB1-14B in the City of Coppell, Texas for the Silver Line Regional Rail Project and Authorize Eminent Domain Proceedings, if necessary.

